

OPERATING MANUAL

DMX Swing Controller Mk3



RoHS
compliant

(C) SOUNDLIGHT 1996-2017 * ALL RIGHTS RESERVED * NO PART OF THIS MANUAL MAY BE REPRODUCED, DUPLICATED OR USED COMMERCIALY WITHOUT THE PRIOR WRITTEN CONSENT OF THE OWNER * ALL STATEMENTS WITHIN THIS MANUAL HAVE BEEN CHECKED CAREFULLY AND ARE BELIEVED TO BE ACCURATE, HOWEVER SOUNDLIGHT DOES NOT ASSUME ANY RESPONSIBILITY FOR ERRORS OR OMISSIONS. * THE USER HAS TO CHECK THE SUITABILITY OF THE EQUIPMENT FOR THE INTENDED USE. SOUNDLIGHT EXPRESSLY EXCLUDES ANY RESPONSIBILITY FOR DAMAGES - DIRECT OR INDIRECT - WHICH MAY OCCUR DUE TO MISUSE, UNPROPER INSTALLATION, WRONG OPERATING CONDITIONS AND NON-COMPLIANCE TO THE INSTRUMENT'S INSTRUCTIONS, AS WELL AS DISREGARD OF EXISTING SAFETY STANDARDS AND REGULATIONS.

Thank you for choosing a SOUNDLIGHT device.

The SOUNDLIGHT DMX Swing Controller SWINGC3 is an intelligent DMX decoder to convert digital data complying with standards USITT DMX512/1990, ANSI E1-11 DMX512-A, DIN 56930-2 and ANSI E1-20 DMX RDM into control signals for driving a pulse driven stepper swing motor. The SWINGC3 can be used with all standard lighting control systems. Its special advantages include:

- **universal protocol decoding**
Recognizes all variants of the protocol as defined by USITT / ESTA / DIN
- **future-proof**
The unit is software controlled and can easily be adapted to any change in protocol definition.
- **signal feed-thru**
The DMX data input is fed to DMX THRU terminals. This allows easy integration in complex multi-device wirings.
- **simple supply**
The power supply is from standard voltage 24VDC.
- **signal loss**
In the case of a loss of the drive signal a pre-definable action will be taken.
- **cost-effective**
The SOUNDLIGHT SWINGC3 is a cost-effective solution for many purposes.

General

The DMX swing Controller SWINGC3 is ideally suited for all kinds of swing motion control. It has been designed for positioning applications in entertainment lighting. The SWINGC3 must not be used for hazardous applications. Certain applications may require additional safety measures (see below). A suitable stepper motor and driver is needed for full operation (see chapter ADDENDUM).

Nomenclature

These symbols are used within this manual:



DANGER ! May cause harm to user and/or equipment



INFO: How to setup your device



INFO: Status information

Unpacking

Please unpack carefully and check that all items are intact. When leaving our factory, the interface has been in good condition. In case of damage during transport please notify the carrier immediately. Please note that specific deadlines may apply to claim transport damages. We will only be able to replace goods damaged during transit if we receive a written and signed confirmation issued by the freight forwarder. Make sure you receive such a document and send to us a.s.a.p.

When unpacking, you should identify these items:

- * the interface SWINGC3 RDM
- * this manual

*Please note that a start address programming adaptor (3000P, 3003P, 3005P or 3006P) is NOT included with DIN rail mount devices. **All settings can be performed using DMX RDM.** Alternatively, a programming adaptor, which can be used to set DMX start address, DMX personality and DMX HOLD mode, **must be ordered separately.** If you already have it, there is no need to buy again: the start address board can be used for all our DMX interfaces, pcb and DIN rail mount alike.*

Connectors

The decoder SWINGC3 consists of 6 terminal blocks. Terminals are based on screwless WAGO cage clamp technology, which prevents loose connections and guarantees safe electrical contact at all times. Use a standard **flat blade** screw driver and press the lever to open the terminal, insert wire and release. Do **not** use a philipps or pozidrive screwdriver to prevent damage ! Though both, solid and stranded wires may be used we recommend to use stranded wires in combination with isolated ferrules whenever possible.

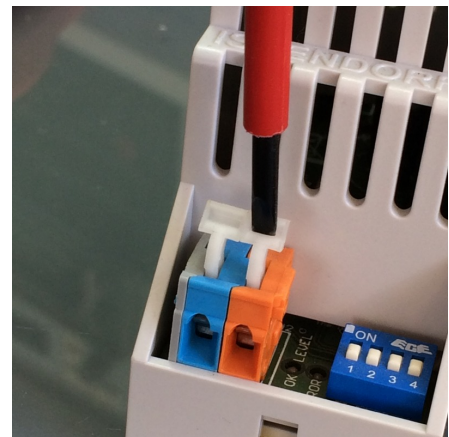

Please refer to the connector location outlined on page 3.

Applications

The decoder SWINGC3 is intended to drive stepper motors using a pulse-driven motor driver. Digital swing stepper motors commonly come with drivers requiring a RUN, a DIRECTION and a STEP input. The SWINGC3 has been designed to work with such a swing system, generating the required drive signals. See appendix for more details.

IMPORTANT NOTICE

The control protocol DMX512 is not intended to control drives and scenery which could be hazardous to man or materials (see standard ANSI E-11 DMX512-A, available from www.ansi.org). This restriction must be similarly applied to previous standards USITT DMX512/1990, DMX56930-2 or standards based on E1-11, such as ANSI E1-20 DMX RDM.

DMX512 does not contain any mechanisms or procedures that allow instant system shutdown in case of malfunction or failure. Thus it is in the sole responsibility of the user to install a second, independent safety circuit to shutdown the application in case of trouble.

The decoder SWINGC3 can be used in positioning mode using two end switches (left and right), or using only one center position detector. Motion range is limited to 3500 steps max. The unit can be configured using DMX RDM, and setup can be performed using any standard DMX RDM controller. We suggest to use the JESE GET/SET DMX RDM controller RDM-TRI (www.jese.co.uk), being the most advanced, versatile and reliable controller software available.

Connections

CN1 DMX DATA INPUT

1	grey	GND
2	blue	-DMX
3	red	+DMX

CN2 DMX DATA THRU

1	grey	GND
2	blue	-DMX
3	red	+DMX

CN3 DRIVE OUTPUTS

1	red	24VDC
2	red	24VDC
3	d'grey	Output: ENABLE
4	d'grey	Output: CLOCKWISE
5	d'grey	Output: CLOCKPULSE
6	d'grey	Output: DRIVE
7	blue	0V, GND
8	blue	0V, GND

CN4, CN5 END SWITCHES

1	grey	Left Switch
2	grey	Center Switch
3	grey	Right Switch
4	blue	0V, GND

End switch inputs are polarity sensitive and must be driven from 24VDC. Refer to wiring schematics for more information.

CN6 POWER SUPPLY

1,2	blue	Power Supply 0V, GND
3-6	red	Power Supply +24VDC

CN8 Start address board (10-pin)
To connect a SOUNDLIGHT start address board 3000P or 3006P.

NOTES:

- End switches (R/L)
End switches shall be disengaged while (and as long as) the motor is running and the end position has not been reached. End switch polarity can be changed by RDM.
- Zero point sensor input (Center Switch Input)
The sensor input expects a positive input voltage and will reset the position counter to „00000“ at the positive flank of the input pulse.

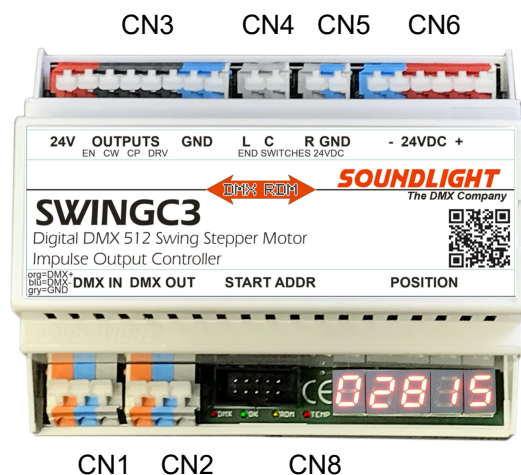

Signal Indicators

The status of the SWINGC3 module is signalled with three indicator LEDs.

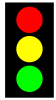

green: OK

A valid DMX control signal is present.

red: ERROR

normally: off

blinking: no valid DMX signal present

Yellow: RDM

Activated when a RDM programming has taken place. Mechanical address switches are deactivated then.

Start Address

The start address can be set by DMX RDM using the `START_ADDRESS` command (PID \$00F0). The start address defines the address of the first data slot used by the decoder. Valid start address settings include start address 001 thru 512-(number of slots used).

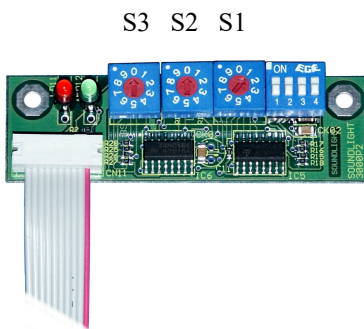

When using a mechanical start address board 3000P the coding switches give the start address directly. No binary conversion as needed with DIP switches necessary.

S1: Ones

S2: Tens

S3: Hundreds

When setting the address to 000 (invalid setting for DMX data reception), all outputs will be set to „off“ regardless of DMX data.

The decoder can be operated with or without start address board connected. Please note that switches become disengaged and the respective settings are overridden when programming is done via RDM. To re-engage the switches, set the hundreds position to „9“ temporarily and wait for a programming cycle to complete. A programming cycle is indicated by the red and the green LED blinking four times alternatively.

DMX HOLD Mode

The DMX HOLD mode defines the behaviour at signal loss. Signal loss is defined as loss of a valid DMX control signal for more than 1 second. There are three options present, which can be selected by RDM command `DMX_HOLD` (PID \$80F1):



Parameter Setting

00	all outputs to OFF:	Motor goes to START position
01	all outputs to ON:	Motor goes to END position
02	keep last look:	operation continues as if last received value were present
03	center position	Motor goes to CENTER position („Emergency“)

Setting the HOLD mode can also be performed using the DIP switches onboard the 3000P address board.

DIP-SWITCH 1: HOLD MODE
keeps the actual motor position at signal loss
 ON: HOLD Mode activated („keep last look“)
 OFF: no HOLD mode

DIP-SWITCH 2: SAFETY LEVEL
Motor position at signal loss when no HOLD mode activated
 ON: Motor goes to END position
 OFF: Motor goes to START position

DMX Personality

The different operating modes are also known as „DMX PERSONALITY“. The DMX personality can be set by DMX RDM using command DMX_PERSONALITY (PID \$00E0) or a external address board. There, DIP switches 3 and 4 will set the personality.

PERSONALITY 1: DUAL ENDSWITCH MODE

In positioning mode using two end switches, the motor will turn as long as required to reach the preset position as defined by the POSITION HI / POSITION LO faders. The motor will stop as the position has been reached or soon as one end switch has been detected and motion beyond that point is prohibited.

When triggering the „left“ endswitch (position „0000“) the position counter is automatically updated and being reset.

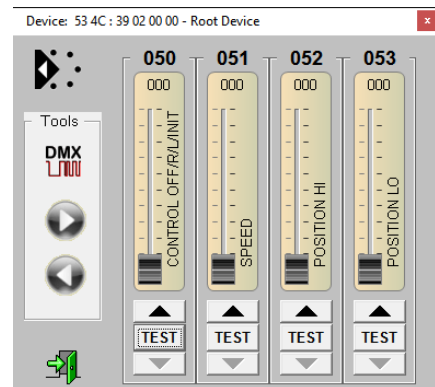

Position	POS counter <i>decimal</i>	DMX position value		
		<i>fader hi</i>	<i>fader lo</i>	<i>decimal</i>
LEFT (CCW)	0000	0	0	0
MID POSITION	1407	128	0	32767
RIGHT (CW)	2815	255	255	65535

Thus the maximum range is 2815 steps.

The DMX positioning uses DMX data slots 3 (HI) and 4 (LO). The total value is calculated from $POSITION = 256 * HI + LO$. Thus the mid position is: $MID = 128 * 256 + 0$, that is, Fader 3 must be set to „128“ and Fader 4 must be set to „0“.

DMX slots 1 and 2 are used to control the movement.



Fader 1 CONTROL

0...203: off
 204-216: Initialize
 217...255: ON

Fader 2: SPEED (output voltage 0...10V)
 0: Minimum Speed
 255: Maximum Speed

DMX PERSONALITY 2: CENTER MODE

In positioning mode using a center sensor detector, the motor will turn as long as required to reach the preset position as defined by the POSITION HI / POSITION LO faders. The motor will stop as soon as the position is reached. When crossing the mid position sensor from left to right (increasing position values) the actual position is automatically updated.

Fader 1 CONTROL

0...203: off
204-216: Initialize
217...255: ON

Fader 2: SPEED (output voltage 0...10V)

0: Minimum Speed
255: Maximum Speed

DMX PERSONALITY 3: TEST MODE

This personality does not show any slots, thus there is no control possible. Personality 3 is solely used to test switch functionality at system setup.

The display will show the status of the left, the center and the right switch input from left to right, and displays „L“ for Low Level, and „H“ for High Level at the input.

Display when no endswitch triggered:



Display when center switch and right switch active:



Switch functions can be individually inverted using Function \$8438 „INPUT POLARITY“

DMX PERSONALITY 4: DEBUG MODE

This personality is used to test stepper motor driver functionality at debug level at system setup. Each fader controls one output directly.

Fader 1 OUTPUT: EN
Fader 2 OUTPUT: CW
Fader 3 OUTPUT: CP
Fader 4 OUTPUT: DRV

Outputs are switching to GND, thus all loads must be referenced to +24VDC. See wiring diagrams for more information.

Using the start address board 3000P, DIP switches 3 and 4 are used to set the personality. Assignment is as follows:

Personality	DIP3	DIP4
1: Dual End Switch Mode	off	off
2: Center Sensor Mode	off	on
3: Sensor Display Mode	on	off
4: Debug Mode	on	on

Initialization

In position mode a automatic initialization routine will be invoked at power-up or when issuing a RESET command by RDM or control fader 1 (Initialize: see above).



The initialization is performed in two steps:

- 1) Initialization CCW**
 The decoder will be set to CCW direction and the output will be set to initialization speed
 ->End switch reached: the direction will be reversed (CW)
- 2) Initialization CW**
 The decoder will be set to CW direction and the output will be set to initialization speed (can be set by RDM command INITIALIZATION_SPEED, PID \$C008).
 -> MID point detected: the counter will be reset (0000), the motor stops or moves to the preset position, if position HI/LO is other than 128/0
 ->End switch reached: machine stops, „Error“ displayed. Manual intervention is required since no mid / center position has been detected.

Wiring

Please refer to the wiring scheme to make the connections to the decoder. Make sure that all work must only be carried out in unpowered state - disconnect all power supplies before other connections are made.

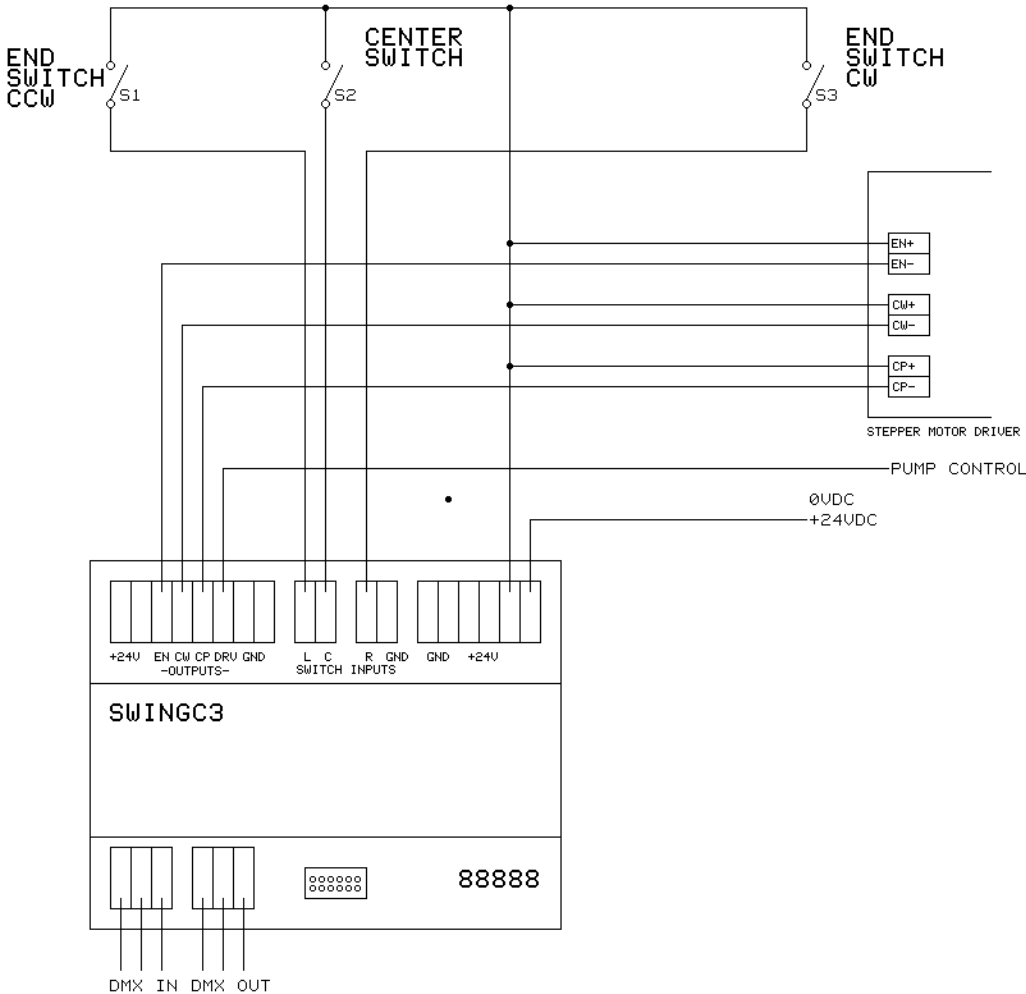

All parts and components used with the SWINGC3 controller must be capable to operate with and from 24VDC. Zero point sensor and end switches can comprise of contact outputs or electronic outputs- refer to the connector description (see page 4) for more details.

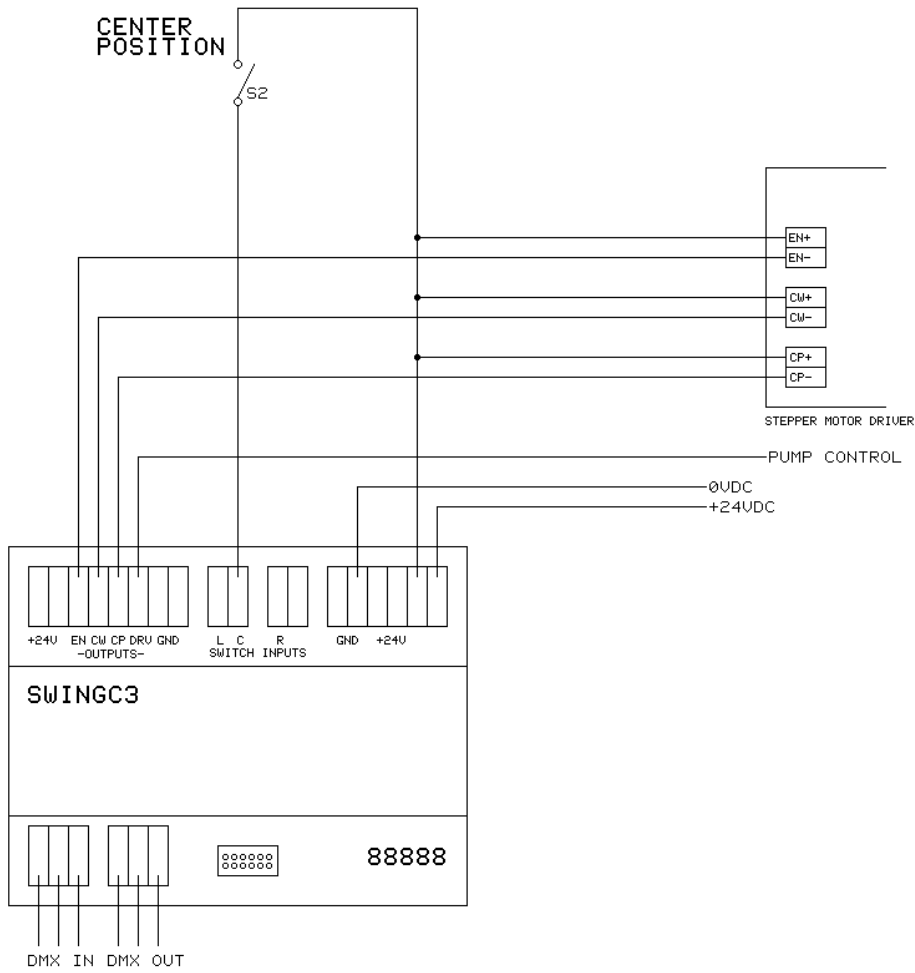

Wiring for center sensor only mode

End Switch / Wiring

The Endswitch/Sensor inputs accept 24VDC signals and are independent of polarity. This allows to use either negative or positive driven signals. Additionally, the polarity of the end switch inputs can be inverted electronically (dual endswitch mode only), thus N.O. or N.C. contacts can be used at your option.

Please refer to the wiring diagrams to connect end switches. After installation, proper functionality should be tested using personality #3. Using the slowest speed possible, also make sure the motor stops going the current direction as soon as the end switch is activated. Failure to do so may result in serious damage.

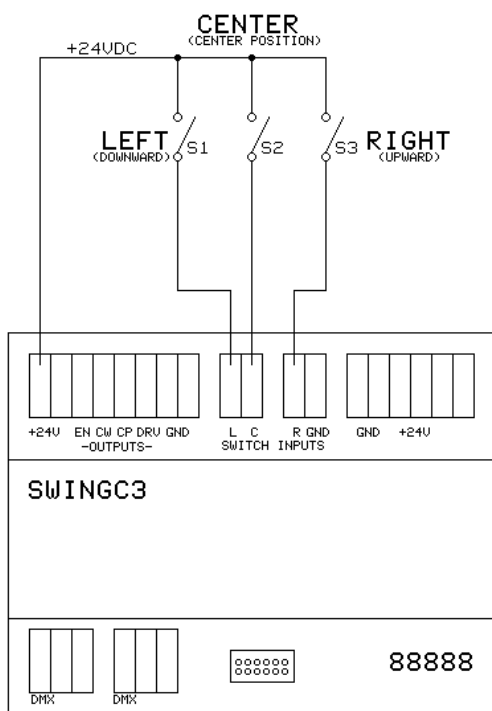

End switch wired for positive signal

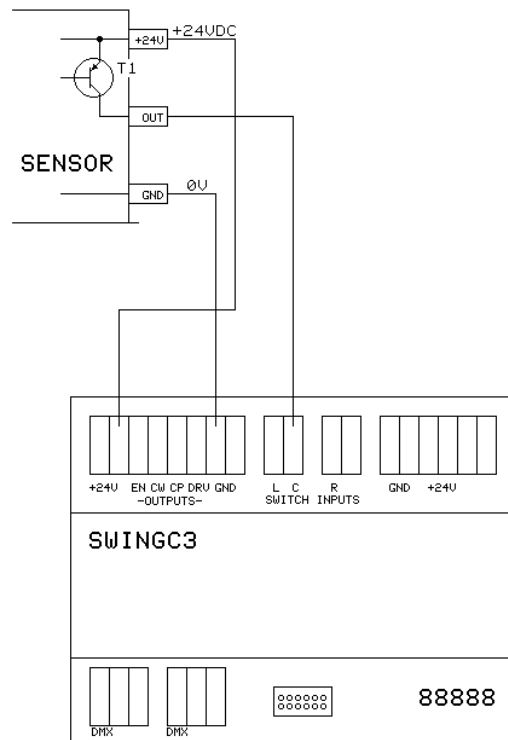

Center Sensor with pnp output

Wiring schemes apply to both sensor inputs. Polarity setting applies to both inputs; mixed mode is void. We strongly recommend to select a operating mode to keep the unit working while the end switches are closed. That will also prevent the system from failures resulting from broken wires, worn-out contacts etc.

Display

The display shows these information:



- Position display**
In positioning mode, the current position will be displayed. Position is always referenced to leftmost (CCW) position (start position 00000). From center position, up to 2815 steps can be reached clockwise (display: „2815“).
- Function display**
When the initialization fails or positioning limits are exceeded, the systems stops and a error message is displayed.
- Test display**
In personality 3, the display shows the activated sensor inputs (see above).



DMX RDM

The SWINGC3 is compatible with ANSI E1-20 DMX RDM Version 1.0. Please note some special properties of devices complying with DMX RDM:

- DMX HOLD properties are not supported by RDM standard ANSI E1-20. A factory specific command (DMX HOLD, PID \$80F1) has been added to compensate these restraints. Use parameters 0...2 to set the desired HOLD mode:

- 0: no HOLD, all outputs OFF upon loss of signal
- 1: no HOLD, all Outputs ON upon loss of signal
- 2: DMX HOLD (last look remains active)

- Setting the DMX personality reflects setting of DIP switches 3 and 4 (and vice versa).

NOTE:

Once settings have been changed using DMX RDM, the address switches become inactive (blocked). To re-enable start address switches, temporarily set any address from 900...999 (simply set the "9xx" digit). This will re-enable switches.

DMX RDM Properties

The SWINGC3 RDM is fully compliant to DMX RDM Standard ANSI E1-20 V1.0. The device will be identified as MOTOR ROTATOR in SCENIC DEVICES category and can be configured to four modes of operation (DMX PERSONALITY):

- PERSONALITY 1: Dual End Switch Mode (4 DMX data slots)
The motor will automatically drive to reach the preset position, given in 16 bit format and defined by DMX data slots 3 (HI) and 4 (LO). Please note, that all entries must be referenced to start (CCW) position (hex 0000, dec. 0000)
- PERSONALITY 2: Center Sensor Switch Mode (4 DMX data slots)
The motor will automatically drive to reach the preset position, given in 16 bit format and defined by DMX data slots 3 (HI) and 4 (LO). Please note, that all entries must be referenced to start (CCW) position (hex 0000, dec. 0000)

Selecting the appropriate DMX PERSONALITY will set the required mode of operation.

Device: 53 4C : 39 02 00 00

Remote Device
 SOUNDLIGHT The DMX Company
SWINGCONTROLLER Mk2
 Software Version:
 SW Mk 1.0 RDM Mk 4.7

Parameter Key
 Required Parameter Show
 Supported Parameter
 Manufacturer Parameter
 PLASA Reserved Parameter

Root and Sub Devices

Device	Label
Root Device	SWC2 DMX RDM SWING CONTR...

Supported Parameters - Root Device

PID	Parameter
\$0001	DISC_UNIQUE_BRANCH
\$0002	DISC_MUTE
\$0003	DISC_UN_MUTE
\$0015	COMMS_STATUS
\$0020	QUEUED_MESSAGE
\$0030	STATUS_MESSAGES
\$0031	STATUS_ID_DESCRIPTION
\$0050	SUPPORTED_PARAMETERS
\$0051	PARAMETER_DESCRIPTION
\$0060	DEVICE_INFO
\$0070	PRODUCT_DETAIL_ID_LIST
\$0080	DEVICE_MODEL_DESCRIPTION
\$0081	MANUFACTURER_LABEL
\$0082	DEVICE_LABEL
\$0090	FACTORY_DEFAULTS
\$00C0	SOFTWARE_VERSION_LABEL
\$00E0	DMX_PERSONALITY
\$00E1	DMX_PERSONALITY_DESCRIPTION
\$0120	SLOT_INFO
\$0121	SLOT_DESCRIPTION
\$0122	DEFAULT_SLOT_VALUE
\$0141	DMX_FAIL_MODE
\$0200	SENSOR_DEFINITION
\$0201	SENSOR_VALUE
\$0340	DIMMER_INFO
\$0341	MINIMUM_LEVEL
\$0342	MAXIMUM_LEVEL
\$0343	CURVE
\$0344	CURVE_DESCRIPTION
\$0345	OUTPUT_RESPONSE_TIME
\$0346	OUTPUT_RESPONSE_TIME_DESCRIPTION
\$0347	MODULATION_FREQUENCY
\$0348	MODULATION_FREQUENCY_DESCRIPTION
\$0400	DEVICE_HOURS
\$0405	DEVICE_POWER_CYCLES
\$0640	LOCK_PIN
\$0641	LOCK_STATE
\$0642	LOCK_STATE_DESCRIPTION
\$1000	IDENTIFY_DEVICE
\$1001	RESET_DEVICE
\$1010	POWER_STATE
\$1040	IDENTIFY_MODE
\$8341	MIN_MAX_MODE
\$8438	INPUT POLARITY
\$C011	ACCELERATION RAMP
\$C012	DECELERATION RAMP
\$FF01	RDM FACTORY SETUP
\$FF7F	RDM TESTAUSGABE

Special RDM functions:

RESET_DEVICE:

calling with parameter =1 (\$01) causes a warm reset
calling with parameter = 255 (\$FF) causes a cold reset

DEVICE_POWER_CYCLES:

reads the number of device startups

For more information about DMX RDM and its possibilities pls check www.rdm.soundlight.de

The SWINGC3 interfaces additionally make use of some enhanced RDM functions, including:

FUNCTION \$C011 ACCELERATION RAMP

FUNCTION \$C012 DECELERATION RAMP

This function sets the ramp for acceleration (*currently not yet used*) or deceleration of the stepper motor. 8 values must be given to define the acceleration curve, with full speed = \$FF and zero speed = \$00. See example for more details.

Calls: GET <param = none> (no parameter needed)

Return: <param=Ramp [8 Bytes]>

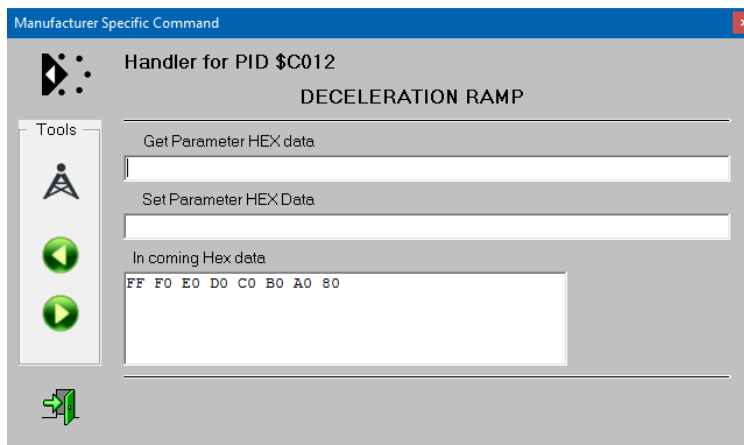

GET Mask

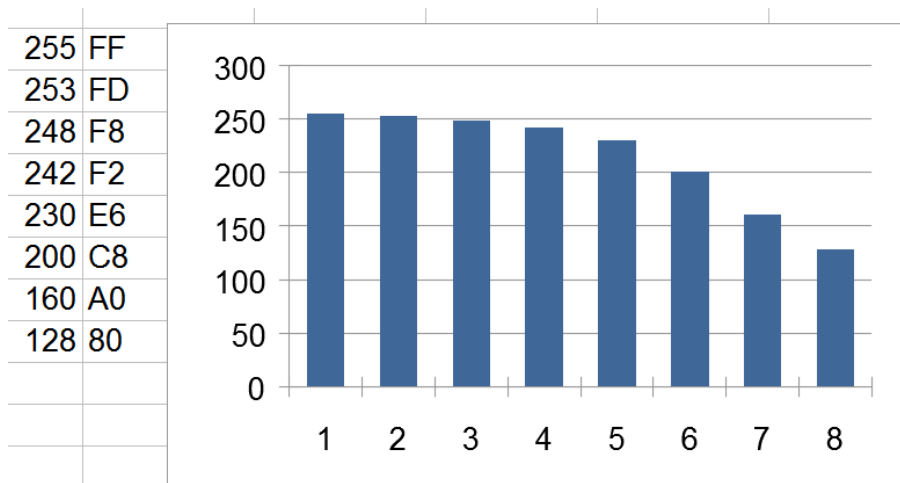

Ramp design

SET <param=Ramp [8Bytes]>

Return: <param=none> (no parameter returned)

Ramp = \$00...\$FF the value will be taken as speed factor

FUNCTION \$C013 MOVING RANGE

This function sets the total moving range of the nozzle. The standard resolution (when setting the stepper motor driver as stated in the addendum) is 32 steps per degree. This will result in the settings as per table 1:

Angle [°]	Steps	Hexadecimal
30	960	03C0
45	1440	05A0
60	1920	0780
90	2880	0B40
120	3840	0F00
150	4800	12C0
180	5760	1680

Table 1 Angle Step setting

Calls: GET <param = none> (no parameter needed)
Return: <param=StepSetting [2 Bytes]>

SET <param=StepSetting [2Bytes]>
Return: <param=none> (no parameter returned)

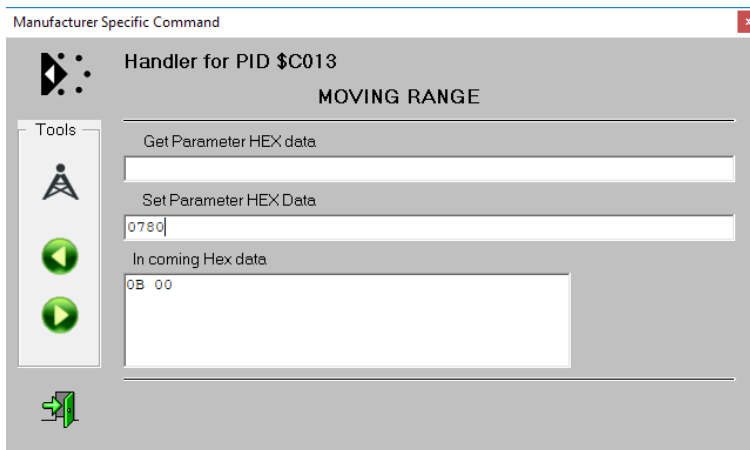

Changing from >90° to 60° (+/-30°) moving range

Adjusting the moving range will automatically scale the position faders to cover the full range.

FUNCTION \$8438 INPUT POLARITY

This function sets the polarity of the end switch sensor inputs. Use personality 3 to display the sensor input status.

Calls: GET <param = none> (no parameter needed)
Return: <param=Polarity [1 Byte]>

SET <param=Polarity [1Byte]>
Return: <param=none> (no parameter returned)

Polarity = \$FF all normal polarity (standard mode)
Polarity = \$00 all inverted polarity

From firmware version 1.1 onward, single switches can be inverted individually. Use personality 3 „Test Mode“ to check for functionality and proper setting of the switch inputs. Switches should be set to show „L“ when disengaged (operational mode) and „H“ when engaged (error mode). Changing the polarity of the center switch will result in changing the center point trigger flank.

RIGHT SWITCH: Bit 0 (normal: add value 1, inverted: add value 0)
CENTER SWITCH: Bit 1 (normal: add value 2, inverted: add value 0)
LEFT SWITCH: Bit 2 (normal: add value 4, inverted: add value 0)

Normal Mode: Bit set
Inverted Mode: Bit not set

*Example: to invert the right and the left end sensor switch input, add 1+4 = 5.
 Thus Polarity = \$05*

FUNCTION \$FF01 RDM FACTORY SETUP

for factory use only

FUNCTION \$8438 RDM TESTAUSGABE

for factory use only

More RDM Info

For more information on DMX RDM pls check the web pages of the DMX RDM protocol group (www.rdmprotocol.org), or visit: www.rdm.soundlight.de

Technical Data

Dimensions:	DIN rail module (REG) 6.5 units
Power supply:	24V DC
DMX IN:	1 Unit Load
DMX OUT:	fed thru
Protocol:	DMX512/1990, DIN56930-2, DMX512-A, DMX RDM
End Switch IN:	24VDC, potential-free and polarity insensitive, max. 5mA
Steps:	2815 max.
Motor Out:	EN, CW, CP
Operating Temperature:	0...+50C
Order Code.:	SWINGC3

CE CONFORMITY



This DMX interface is microprocessor controlled and uses high frequency. The interface has been tested in our EMC lab to comply with DIN EN55015 and IEC65/144.

To ensure the best performance regarding radiated and conducted emissions we suggest to install the interface in a closed, conductive (e.g. metal) housing, which must be connected to GND.

Please make sure that shielded data cable is used and the shield is connected properly to the GND pin. Shield must never make contact to other signal lines.

FCC STATEMENT

This product has been tested and complies with the specifications for a Class B digital device, pursuant to Part 15 of the FCC Rules. These limits are designed to provide reasonable protection against harmful interference in a residential installation. This equipment generates, uses, and can radiate radio frequency energy and, if not installed and used according to the instructions, may cause harmful interference to radio communications.

However, there is no guarantee that interference will not occur in a particular installation. If this equipment does cause harmful interference to radio or television reception, which is found by turning the equipment off and on, the user is encouraged to try to correct the interference by one or more of the following measures:

- Reorient or relocate the receiving antenna
- Increase the separation between the equipment or devices

- Connect the equipment to an outlet other than the receiver's
- Consult a dealer or an experienced radio/TV technician for assistance

FCC Caution: Any change or modification to the product not expressly approved by SLH could void the user's authority to operate the device.

DISTURBANCES

If a trouble-free operation cannot be guaranteed, disconnect the relay card interface and secure it against unwanted operation. This is especially necessary, when

- the unit has visible damages;
- the unit does not operate;
- internal parts are loose;
- connection cables show visible damages.

LIMITED WARRANTY

This DMX interface is warranted against defects in materials and workmanship for a period of 12 months, beginning with the date of purchase. The warranty is limited to repair or exchange of the hardware product; no further liability is assumed. SOUNDLIGHT is not responsible for damages or for loss of data, sales or profit which arise from usage or breakdown of the hardware product. In Germany, SOUNDLIGHT will repair or replace established defects in hardware, provided that the defective part is sent in, freight paid, through the responsible dealer along with warranty card and/or sales receipt prior to expiration of warranty.

Warranty is void:

- when modifying or trying to repair the unit without authorisation;
- modification of the circuitry;
- damages by interference of other persons;
- operation which is not in accordance with the manual;
- connection to wrong voltage or current;
- misuse.

SERVICE

There are no parts within the DMX controller SWINGC3 which require the user's attention. Should your unit require servicing, please send it to the factory, freight paid.

END OF LIFETIME



When the useful lifetime of this product has been reached, it must be disposed of properly. Electronic devices must not be placed in domestic waste. Consult your local authorities to find the nearest collection point of used electric and electronic devices. SOUNDLIGHT is a WEEE registered company (Reg No. DE58883929).

INTERNET-HOTLINE

Please check our internet domain <http://www.soundlight.de> for new versions, updates etc. If you have any comments which may be worth considering, please send a message to **support@soundlight.de**. We will check your message and reply accordingly.

Updated and foreign language manuals can be downloaded from www.manuals.soundlight.de

The SWINGC3 product page can be found at www.soundlight.de/produkte/swingc3

ACCESSORIES

To set the DMX start address and change the operating parameters, a DMX RDM controller or a start address board is needed. These boards are optionally available:

DMX START ADDRESS BOARD 3000P

www.soundlight.de/produkte/3000p

Three address BCD switches and a DIP switch to set operating parameters. This is the standard board, which is compatible with all our decoders (both PCB and DIN rail mount)

DMX START ADDRESS BOARD 3006P

www.soundlight.de/produkte/3006p

Start address board with LCD display and rotary encoder to set the DMX start address. Address is retained in nonvolatile onboard memory.

DMX RDM CONTROLLER GET/SET USBRDM-TRI

www.soundlight.de/produkte/usbrdm-tri

Intelligent controller software for use on Windows machines. Complete with USB connected interface connecting to DMX responders or introduce RDM control when working with other DMX control gear.

Start address boards are not contained with DIN rail mount decoders and must always be ordered separately!

Addendum

The SWINGC3 will work with swing nozzle systems (e.g Jiayin JYSPA-40 or JYSPA-50) using a standard swing motor (e.g. stepping motor 85BYGH) and the motor driver box (e.g. CW250)m plus transformer for motor power supply. Pictured is the standard motor, using a center position inductive sensor (use SWINGC3 personality 2 to work in center sensor mode). The motor driver box should be set to highest resolution (1/250 step width).

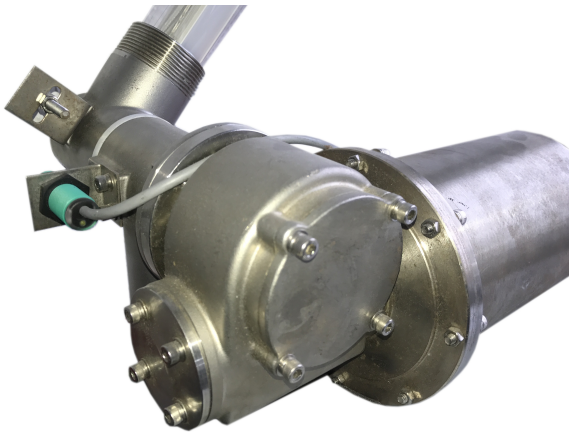

Thus: DIP5 = ON
 DIP6 = ON
 DIP 7 = OFF
 DIP 8 = ON

Set the motor current to match the motor used.
Wire the driver box as indicated on page 8/9

Use the DRV output as optional inhibit signal to control the water pump. The output signal is HIGH as long as the initialization sequence is performed, and will go LOW when the Swing controller is ready for show.

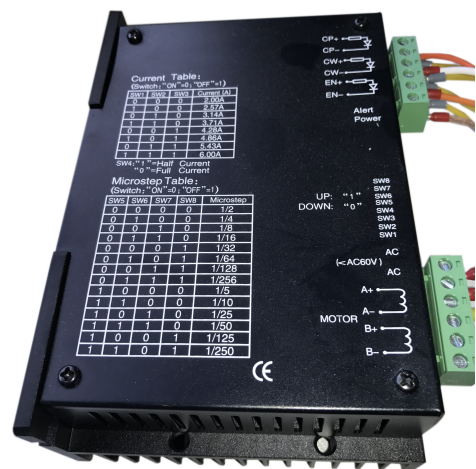

Since the Jiayin JYSPA-40 / JYSPA-50 only features a center sensor, the swing controller must be set to personality 2 (CENTER MODE). Also please note, that the sensor must be attached to SENSOR 2 (R) input for proper operation.

At power up, the stepper motor can randomly start in any position. During initialization, the motor swings to the left, then to the right alternately using a increased span for each run. As soon as the center sensor is triggered, the initialization routine stops and the motor goes to the actual DMX position at the set speed.

Thus it is necessary to ensure that the nozzle head is able to **run a full rotation** without any obstructions. If the center sensor point cannot be found within three initialization runs, the controller will stop showing a error condition. Check the nozzle, check the sensor for functionality and eventually run another initialization. To do so, set DMX slot #1 (CONTROL) to any value between 204 and 216, then to full (255) to allow show control.